



# Careline Alarm User Installation Guide

## 1.1 IMPORTANT INFORMATION



The user's telephone **MUST BE** connected to the **Reach TEL** socket - a double adapter on the incoming line must not be used.



If the user has a DECT telephone the base station **MUST BE** at least 2 metres away from the **Reach**. Failure to provide this separation may result in reduced range of personal pendants or other radio devices.



REN1

All telephone equipment has a Ringer Equivalence Number (REN) which is used to calculate the number of items that can be connected to a single telephone line. A REN of 4 is the maximum allowed on a standard UK telephone line. The **Reach** has a REN of 1. If the REN total of all equipment connected to a telephone line exceeds 4, the equipment may not operate correctly. With different types of equipment there is no guarantee of correct operation even if the REN is less than 4. Typically 1 or 2 standard telephones (REN1) can be used with the **Reach**.



Avoid using strong detergents or polish when cleaning the **Reach** unit or **Touch** pendant. Wipe clean with a damp cloth and polish with a dry duster.

## 1.2 UNPACKING THE REACH AT-HOME ALARM

The **Reach** At-Home Alarm is supplied with a Power Lead, a Telecom lead, a **Touch** pendant and a wearing kit. A stand can be fitted if the unit is being mounted upright or a connector cover if it is being placed flat. The stand/cover must be fixed with the screw provided.



**Touch Pendant Pack Contents**



**Fall Sensor Pack Contents**



**Reach At Home Alarm Unit**  
(also available in black)



**Power Lead**



**Reach At Home Alarm Unit**  
(also available in black)



**Power Lead**



**Stand & Cover Screw**



**Wearing Kit**



**Stand & Cover Screw**



**Connector Cover**



**Telecom Lead**



**Connector Cover**



**Telecom Lead**

## 1.3 THE TOUCH PERSONAL PENDANT

The **Touch** pendant can be used to make an emergency call from anywhere in or around the home. The **Touch** pendant is waterproof but it should not be fully submerged for long periods.



**The Touch pendant is a life saving device; remember to advise the user to wear it at all times and keep it by their bed at night.**

The **Touch** pendant is supplied with a kit of parts so it can be worn around the neck, clipped onto a belt or pocket, or on the wrist like a watch.

Snap the **Neck Cord** apart at the safety break device and feed through the 2 holes in the rubber boot, then click together again. The neck cord must never be shortened or knotted without the safety break in place.

Push the **Belt Clip** through the 2 slots in the rubber boot - ensure the 2 arrows on the clip and boot align for correct fit. The suction cup can be used with the clip option to stick the **Touch** pendant to a tiled wall when in the bath or shower.

Push the **Wrist Strap** through the 2 slots in the rubber boot and adjust the strap to fit.



Additional pendants and rubber boots are available separately if more than one is required. Replacement wearing kits are also available as spares.

### **Making an Emergency Call...**



Simply press the Touch Pendant button once.

The button will **FLASH RED ((●))** for several seconds to confirm a call is being made.

**The Reach will announce "Pendant alarm - Please wait, dialling for assistance"**



The **Touch** pendant battery should last for about 3-5 years depending on use.

The battery condition is checked every day, if the voltage falls and stays below preset level for 7 consecutive days a "low battery" call will automatically be sent to the Control Centre.

Pendants must be returned to Tynetec for battery replacement.

## 1.4 CONNECTING THE REACH AT-HOME ALARM

### Basic Connections...

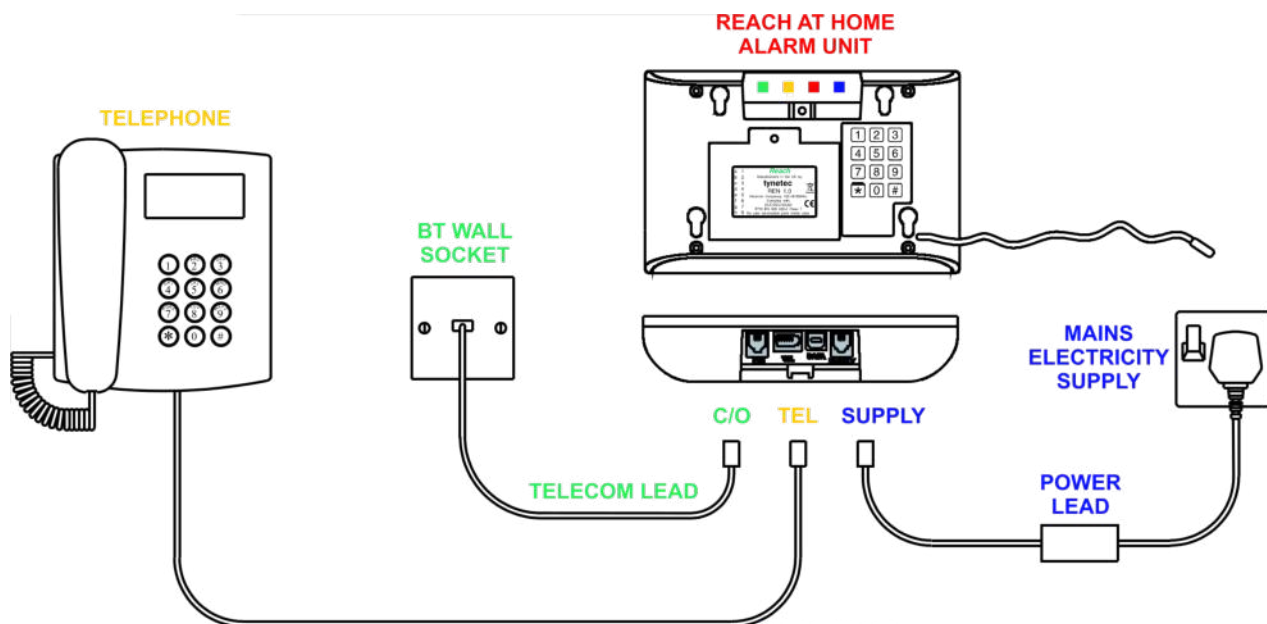

The **Reach** will usually be table mounted within 3 metres of a mains supply and the master telephone socket. If extension cables are used care should be taken to ensure that no one trips over the leads.

### Installation Procedure...

1. Unplug the user's **Telephone** from the BT wall socket and plug it into the **Reach** ■ **TEL** socket.
2. Connect the **Telecom Lead** between the **Reach** ■ **C/O** socket and the BT wall socket (where the user's telephone was originally plugged in).
3. Connect the **Power Lead** between the **Reach** ■ **SUPPLY** socket and the mains electricity supply.
4. Choose the connector cover if the unit is being placed flat on the table or the stand if it is being placed in the upright position. It can also be wall mounted using the key holes on the rear. A template is provided on the carton flap to mark the wall before drilling (wall plugs and screws not included).
5. Route the leads through the cover (or stand) and fix with the single screw provided.
6. The flexible aerial wire out the side of the unit receives signals from radio devices and must not be cut down in length or coiled up.
7. The **Touch** pendant is pre-learned, any additional pendants or other radio devices should be learned and tested too.
8. Perform a test call to the Control Centre to verify correct installation and programming.

## 1.5 REACH AND BROADBAND

Broadband Service Providers will supply a filter module to plug into the telephone line to allow connection of a computer and a normal telephone. Only one filter module is required to connect the computer, telephone and **Reach** when configured as shown below:

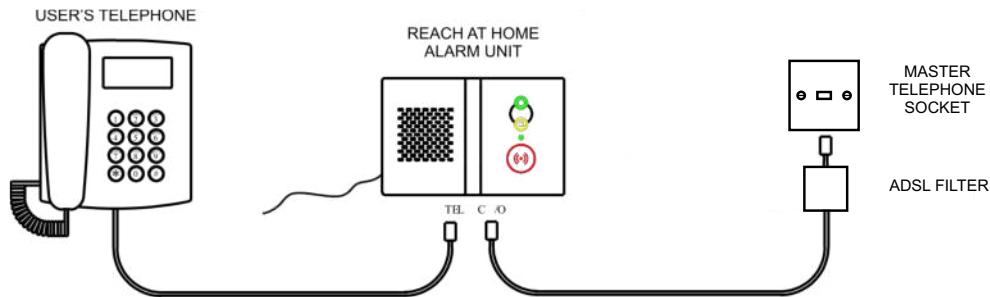

If you experience connection difficulties or noise on the **Reach** audio, then a poor quality filter may be the cause. Approved filter modules are available from Tynetec - Order P/No. W00409

## 1.6 SWITCHING THE *REACH* AT-HOME ALARM ON

Connect the power lead and switch the mains supply on, the front light will flash **RED** / **AMBER** / **GREEN** for about 12 seconds...

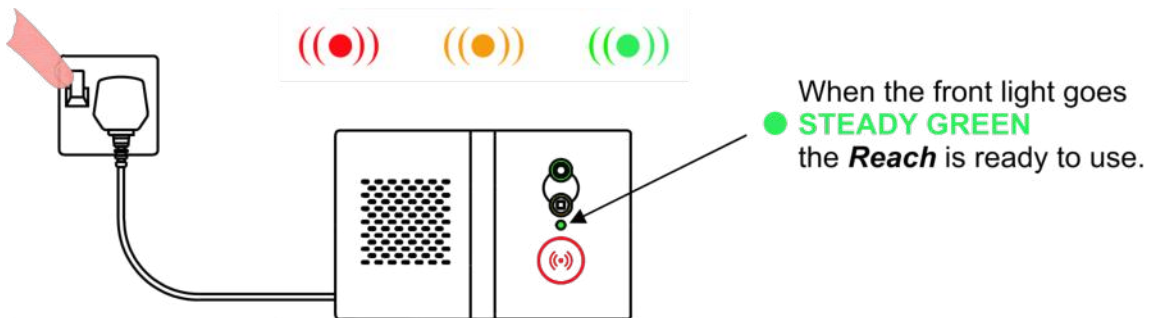

## 1.7 SWITCHING THE *REACH* AT-HOME ALARM OFF

The *Reach* At-Home Alarm uses very little power and should always be left switched ON. If it necessary to switch the unit OFF, follow the procedure below:

1. Turn the mains supply off and wait for the unit to announce...

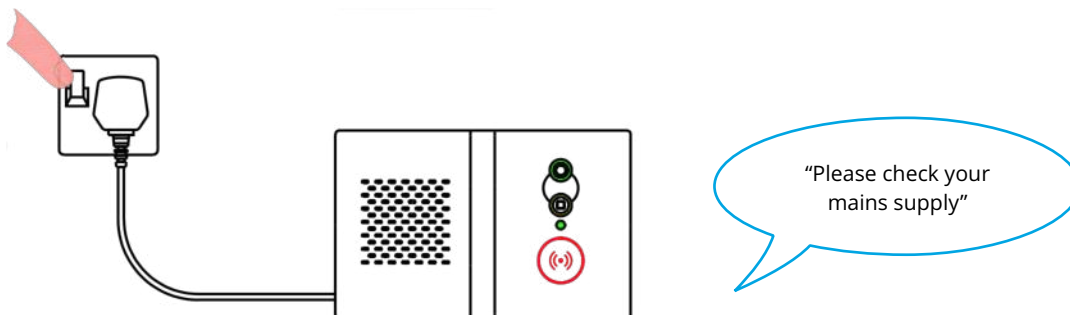

2. Press and HOLD the **GREEN O** button until the unit "beeps" once...



3. RELEASE the **GREEN O** button and the unit will announce...

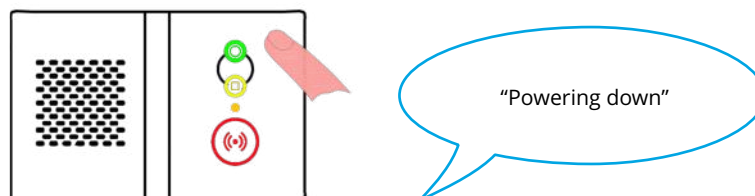

4. The *Reach* is now switched off.



The telephone plugged into the *Reach* will still operate when the unit is switched off.

## 1.8 MAKING AN EMERGENCY CALL

An emergency call can be made at any time of the day or night.

1. Press the **RED ((•))** button on the **Reach** unit or press the **Touch** pendant...

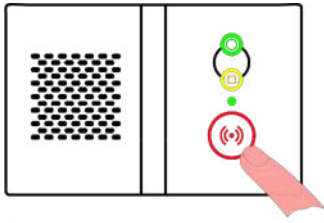

OR



The pendant button will **FLASH RED ((●))** for several seconds after the button is pressed.

2. The **Reach** will start to make an emergency call...

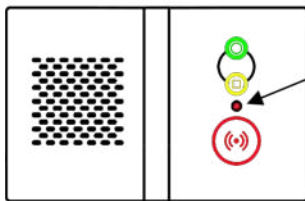

● The front light will go **STEADY RED** and the unit will announce...

"Alarm type"  
"Please wait, dialling for assistance"

This message will repeat for a few seconds before the unit starts to dial.

3. The call will be answered by the Control Centre and an operator will speak...

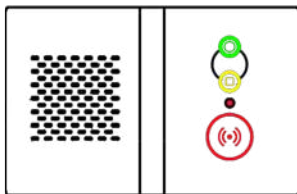

"You're through to Telecare24  
how can I help you?"

4. A two-way conversation can be held with the resident.

5. The operator will cancel the call and the front light will return to ● **STEADY GREEN**.



If the operator cannot hear the caller they will still know where the call is coming from.

The **Touch** pendant does NOT pick up voice, the microphone is in the **Reach** unit and is very sensitive but will not work if the caller is outside their home.

The Control Centre can increase the volume if the caller has difficulty hearing.

## 1.9 ACCIDENTAL CALLS

If an emergency call is made by accident it can be cancelled by pressing the **GREEN O** button once. The unit will announce "Alarm cancelled" and the front light will return to **STANDBY GREEN**.

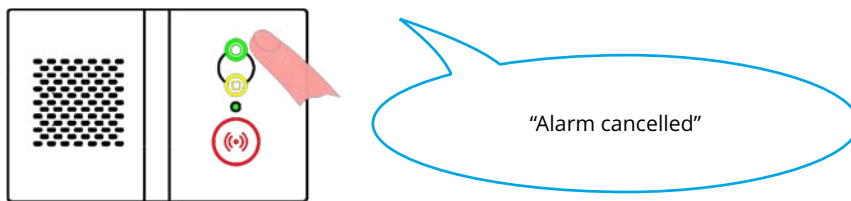

Please note once the **Reach** starts to dial, the call cannot be cancelled.



Advise the user not to worry if they don't manage to cancel an accidental call - when the Control Centre answers they just need to say the call was made in accidentally.

The staff will be pleased that they have talked and they will cancel the call in the normal way.